

# TRAGALDABAS: A new high resolution detector for the regular study of cosmic rays

H. Alvarez-Pol<sup>8</sup>, A. Blanco<sup>3</sup>, J.J. Blanco<sup>1</sup>, J. Collazo<sup>9</sup>, P. Fonte<sup>3</sup>, J.A. Garzón<sup>9</sup>, A. Gómez<sup>7</sup>, G. Kornakov<sup>6</sup>, T. Kurtukian<sup>2</sup>, L. Lopes<sup>3</sup>, M. Morales<sup>9,11</sup>, A. Morozova<sup>4</sup>, M.A. Pais<sup>4</sup>, M. Palka<sup>5</sup>, V. Pérez Muñuzuri<sup>10</sup>, P. Rey<sup>7</sup>, P. Ribeiro<sup>4</sup>, M. Seco<sup>8</sup>, J. Taboada<sup>10</sup>.

<sup>1</sup> Univ. Alcalá. Alcalá de Henares, Spain

<sup>2</sup> CEN-Bordeaux. Bordeaux-Gradignan, France

<sup>3</sup> LIP-Coimbra. Coimbra, Portugal

<sup>4</sup> Univ. Coimbra. Coimbra, Portugal

<sup>5</sup> Jagellonian Univ. Cracow, Poland

<sup>6</sup> TU-Darmstadt. Darmstadt, Germany

<sup>7</sup> CESGA. S. de Compostela, Spain

<sup>8</sup> Depto. de Física de Partículas & IGFAE - Univ. Santiago de Compostela. S. de Compostela, Spain

<sup>9</sup> LabCAF - Univ. Santiago de Compostela. S. de Compostela, Spain

<sup>10</sup> Meteogalicia. Xunta de Galicia. S. de Compostela, Spain

E-mail: [juanantonio.garzon@usc.es](mailto:juanantonio.garzon@usc.es)

**Abstract.** Research on cosmic rays is of big interest either for getting a better understanding about their origin and properties or because they offer very valuable information about the galactic, the solar and the Earth's environment. In order to improve our knowledge of all those fields, a high resolution cosmic ray tracking detector, TRAGALDABAS, is being commissioned at the Faculty of Physics of the Univ. of Santiago de Compostela (Spain). In this article we make overview of the main performances of the detector and we present some very preliminary results showing that the detector is taking good data, and that we are gathering a valuable sample of events, ready to be analyzed.

## 1. Introduction

Cosmic rays coming from the Sun, our Galaxy or other galaxies are permanently arriving to Earth. Most of them are composed by protons, all the remaining atomic nuclei, electrons and also positrons. Their energies range between almost the rest up to about  $10^{20}$  eV for some protons or nuclei, energies that are well out reach of the existing accelerating technologies. Although cosmic rays have been studied for more than one hundred years, many unknowns remain related with their origin and with all the processes affecting them before they arrive to our atmosphere.

Figure 1 summarizes most of the methods used for the measurement of primary cosmic rays as a function of their energy. Below  $\sim 10^{14}$  eV, their rate is big enough to measure them with very high accuracy hybrid detectors placed either in the ISS, in satellites or on balloons [1]. Above

<sup>11</sup> Present address: ICMM/CSIC-Madrid

that energy, hadrons and nuclear fragments produced in the collision of the cosmic ray with the high atmosphere, above the tropopause, start a chain of a few generations of nuclear interactions that may produce over one billion of secondary particles. All those particles constitute what is usually called an Extensive Air Shower (EAS), that spreads out randomly along the atmosphere and that may cover, when they arrive to the ground, up to several hundreds  $km^2$ . As it is not possible to cover such a big area with a dense particle detector, big and broad arrays of detectors are used for measuring the properties of a significative sample of secondary particles on the ground [2].

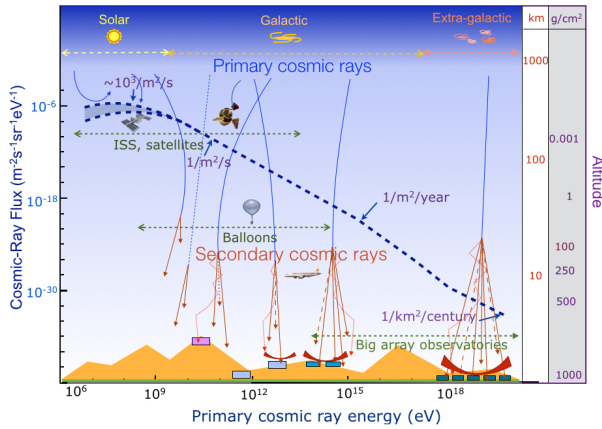

**Figure 1.** Energy spectrum (dark blue dashed line; left scale) of primary cosmic rays together with their corresponding estimated sources and the main detection techniques at different altitudes (right scale)

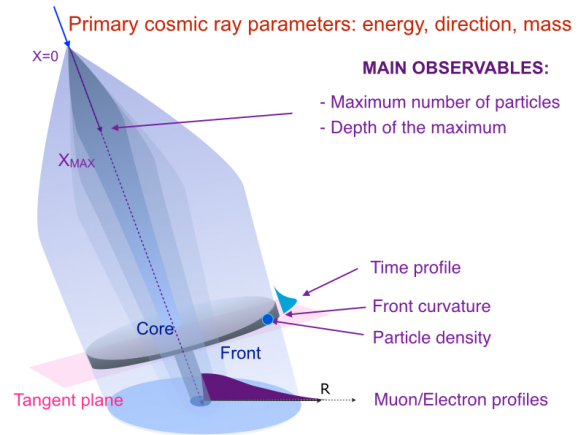

**Figure 2.** Simplified view of the evolution and structure of an Extensive Air Shower (EAS). Most of the secondary particles arrive within a several meters wide front.

As an alternative to the very expensive big arrays used by cosmic ray observatories to measure the high energy cosmic rays, J. Linsley [3] proposed to use mini arrays of detectors measuring a limited sample of the secondaries together with a well known parametrization relating the time width of the bundle of particles with the distance to the core of the shower. Several teams have already shown the viability of the method [4], [5], [6].

A very recent analysis of the time-space microstructure of cosmic rays showers done during the commissioning of a high resolution Time of Flight (TOF) detector designed for the nuclear physics spectrometer HADES, at GSI (Darmstadt, Germany) [7], seems to show that a high granularity relatively small RPC-based tracking detectors ( $\sim 1 m^2$ ) may also provide a good estimation on the arrival direction of the front of the shower and, even, some statistical separation between electrons and muons. As a consequence, it should still exist room for further improvements of the Linsley's method using detectors with more granularity and better time resolution than the ones existing when the idea was proposed.

With all those ideas in mind, a new high performance cosmic ray tracking detector based on the timing Resistive Plate Chamber (tRPC) technology, TRAGALDABAS, has been installed in the laboratory of the LabCAF group at the Univ. of Santiago de Compostela. The detector has an active area of  $1.5 \times 1.2 m^2$  and covers a vertical solid angle of  $\sim 5 sr$  offering a time resolution of  $\sim 300 ps$  and a track arriving angle resolution better than  $3^\circ$ . The device is currently at the commissioning stage and it is taking test data at a rate of  $\sim 7$  millions of events per day. An international collaboration, composed by around 20 researchers belonging to 11 laboratories from 5 European countries, has been organized for the regular maintenance and development of tools allowing to extract all the possible information from the collected data.

In section 2 we describe some of the properties of the cosmic ray air showers. In section 3 we summarize the main features of the detector. In section 4 we show some of the preliminary results obtained during the commissioning period and, finally, in section 5 we summarize the performances of the detector and the research fields that we would like to address to.

## 2. The cosmic ray induced EAS (Extensive Air Showers)

EAS features have been exhaustively studied by many experiments in the last half century, and have been well parameterized for energies of the primary cosmic ray above  $\sim 10^{16}$  eV. Figure 2 shows a summary of the main observables used to characterize single EAS.

A few of the most well known typical features of the EAS are the following [4] [8] [9] [10]:

- At Earth's surface, high energy showers are dominated by high energy muons and low energy electrons and gammas.
- The width of the time profile of the showers, when they arrive to the ground, is narrower near its core than on the edges.
- At a given distance of the axis of the shower, the density of particles in the shower grows with the number of particles generated in the collision region.
- The number of particles generated in the collision is related to both the energy and the mass of the primary cosmic ray.
- The ratio between electrons and muons in the shower grows with the mass of the primary cosmic ray.

As electrons and muons are the most abundant particles in EAS, both particles are the most appropriate to analyze the showers in an event by event basis. Both behave very differently not only in their amount and in their lateral distributions but also in their arrival time distribution and angular distributions [9]. As an example, Figure 3 shows the simulated arrival angle of electrons and muons respect the EAS axis as a function of the distance to the core of the shower for a  $10^{16}$  eV cosmic proton. Differences in the behavior of both particles show that a detector having both good tracking and timing capability would allow to make some separation of these two components in high multiplicity events.

The analysis of the cosmic ray data of the HADES experiment showed evidences of other interesting effects:

- Most of the high multiplicity showers showed a sharp front edge having the same direction as the particles arriving in the firsts *ns*. This effect is compatible with the simulation shown in figure 3 .

- Using well known parameterizations of both the particle density and the arrival time width of high multiplicity events, it was possible to get an estimation of the energy of the primary cosmic ray.

- Many of the bundles of particles detected seemed to show a sparse but lumpy aspect. Perhaps those structures are due to narrow electromagnetic showers induced by the decay of high energy muons. If this is the case, such feature would allow to estimate indirectly the muon content of a shower and, as consequence, to make a guess on the mass (light, medium, heavy) of the primary cosmic ray.

Those and other features of the showers are not usually used in the identification of EAS due to the typical high cost inherent to high accuracy detectors of high energy charged particles. However, RPC technology opens the door to the development of detectors combining high granularity and high time resolution and, using several detection planes, also tracking capability at an affordable price. These features may allow to introduce in the analysis of cosmic ray showers new observables of interest, both for a better estimation of the parameters of the cosmic ray and for a deeper analysis of the relationship between the flux of cosmic rays at Earth's

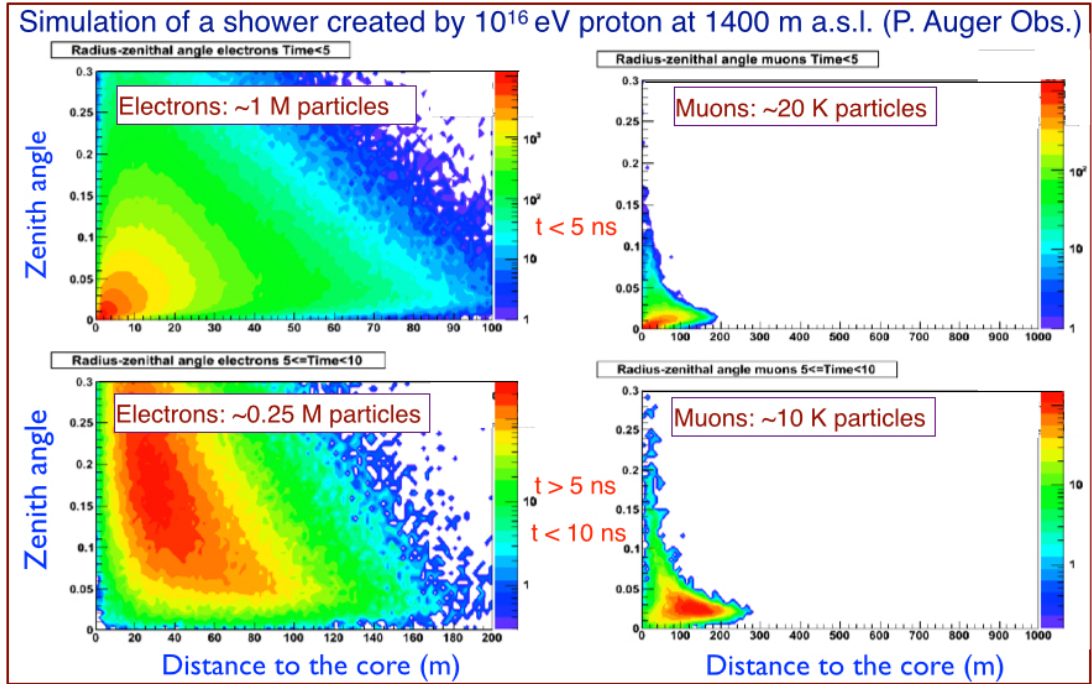

**Figure 3.** Shower simulation for a vertical proton with  $E_0 = 10^{16} eV$ , using AIRES [11]. Pictures show the zenith angle of electrons and muons as a function of the distance to the core of the shower at the height of 1400m a.s.l., both for arrival times  $t < 5 ns$  and  $5 ns < t < 10 ns$ . Note: observe the different scale on the horizontal axis and in the color code in the figures.

surface and other well known effects related with the Earth surroundings like the solar activity, the presence of solar plasma clouds, the interplanetary magnetic field, the Earth magnetic field and the Stratosphere temperature among others.

### 3. TRAGALDABAS

TRAGALDABAS is the acronym for "TRAsGo for the AnaLysis of the nuclear matter Decay, the Atmosphere, the earth B-Field And the Solar activity". The detector has been built following most of the features of the TRASGO philosophy [12] and most of their technical features have been already described in [13].

Figure 4 shows a picture of the detector with its layout during the ECRS-2014 Conference. The detector was composed by two RPC planes with an active size of  $1.2 \times 1.50 m^2$ , placed horizontally at a distance of  $\sim 1.2 m$  each one. It is installed on the first floor of a two-floor building, that will slightly affect the lowest energy EM component of the showers that is not relevant for most of the studies we pretend to carry out. The detector is at the geographical coordinates (N  $42^\circ 52' 34''$ , W  $8^\circ 33' 37''$ ), at  $\sim 260 m$  above the sea level (a.s.l.). We estimate that the corresponding geomagnetic cutoff is of the order of  $\sim 6.5 GV$ .

The detector uses the RPC planes proposed as upgrade of the P. Auger observatory in Argentina [14]. Figure 5 shows the internal layout of each of the RPCs planes and how the read-out digitized pulse is made up in each pad. Each active plane is made by three slides of 2 mm-wide glasses with a 1mm-gap in between, placed inside a gas tight Methacrylate box. As ionizing gas the detector uses freon R134a at a very low flux of  $\sim 7-8 cc/min$ . The external surface of the external glass plates are covered by a conductive coating where the high voltage is applied; the nominal value is  $\sim 5600 V$  with opposite sign in each side, providing an equivalent

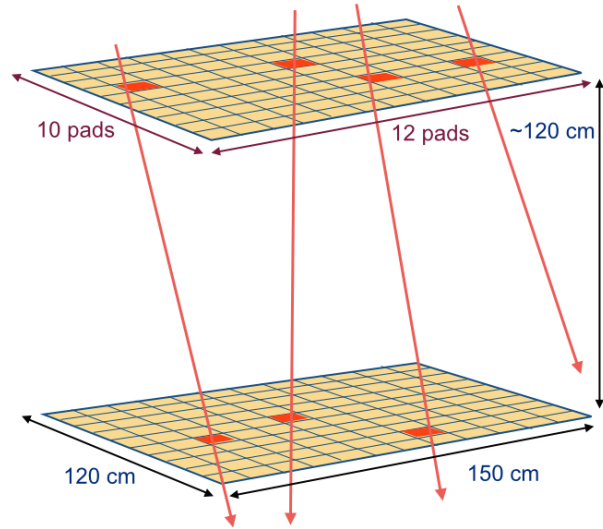

**Figure 4.** Left) Picture of the TRAGALDABAS detector in the laboratory. Right) RPC-planes and pad layout of the detector. The outstanding time resolution of the detector ( $< 300$  ps) will minimize the wrong assignment of pads to a track (ghost track).

voltage of  $\sim 5600$  V/mm in each gap. The read-out is done by 120 rectangular Cu-pads placed in the outer side of the box with a size of  $111 \times 116$  mm<sup>2</sup> each and at a 10 mm distance one of each other. Pads are separated by straight guard-electrodes 6 mm wide to prevent the crosstalk, which is almost negligible. Taking into account both the inner Methacrylate and the external Al boxes, the outer size of each RPC plane is  $1650 \times 1285 \times 26$  mm<sup>3</sup>, its weight is of the order of 90 kg and the mean radiation length is  $\sim 0.27$ .

As read-out front end electronics (FEE), the TRAGALDABAS uses the same electronics developed for the RPC TOF wall of the HADES spectrometer [15]. The FEE is based in a motherboard (MB)- daughterboard (DB) philosophy. In the 4-channel DBs, RPC signals are first amplified and integrated and then digitized in LVDS standard levels. The leading edge of the signal gives the arrival time of the particle and, in the width of the signal, the induced charge is codified by a "charge to width" (QtoW) method. Each MB houses eight DBs, giving them the low voltage and the output for both the digital read-out and the trigger signals. The four MBs collecting all the signals of a RPC plane are read-out by a TDC based read-out board (TRB.V2) [16]. The TRB.V2, developed at the GSI for the HADES experiment, is controlled by an ETRAX processor that sends the data to the external data acquisition computer via Ethernet. The joint detector-acquisition electronics chain provides a time resolution of  $\sim 280$  ps sigma and an efficiency close to 100%. Every plane is equipped with a set of temperature, humidity and pressure probes, building a I2C bus, for the regular monitoring of those magnitudes.

Some of the main performances offered by the detector are:

- Granularity: 120 pads / plane; pad size: 130 cm<sup>2</sup>.
- Angular resolution:  $< 3^\circ$
- Time resolution:  $\sim 280$  ps.
- Hit efficiency:  $\sim 100\%$

#### 4. Preliminary results

The detector is now in the commissioning phase and it is taking data with coincidence trigger between both planes, at a rate of about 7 millions of registered events per day. Every day the

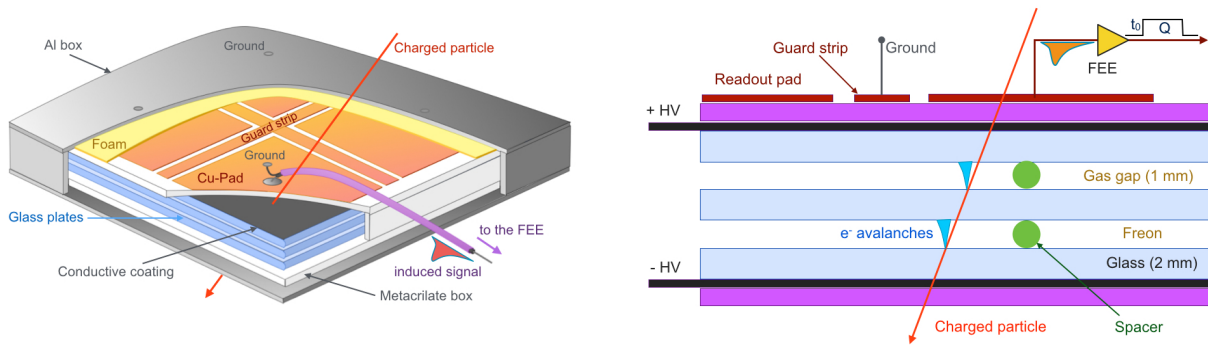

**Figure 5.** a) Schematic view of a detector plane showing most of each components . b) Cut of a RPC cell showing how a digitized readout signal is created. A LVDS signal codifies the arrival time  $t_0$  of the particle in the leading edge of the signal and the induced charge  $Q$  in its width.

data is compacted and sent to a supercomputing center (CESGA) for their definitive storage and handling. Some control test have been done on single data files showing that, globally, the detector is working quite properly. The data analysis will still require, together with the well known both temperature and pressure corrections, some effort including the unpacking of the data together with the calibration, cell synchronization and track reconstruction tasks.

Figure 6 represents, on the left side, the hit multiplicity distribution of data gathered during a week. It can be seen that most of the triggers correspond to events with multiplicities  $M = 1$  or  $M = 2$  and more than half million of triggers every day having a multiplicity  $M > 7$ . On the right side, the figure shows a typical hit map of events belonging to a single file of data. The two main accumulations on the middle of the detector do correspond to the expected distribution of cosmic rays. The black region on the bottom-left side of the upper plane correspond to a couple of disabled cells. Other structures on the corners and on the edge of the detectors may be due to secondaries produced at the support structure, the NIM electronic or the power supply devices.

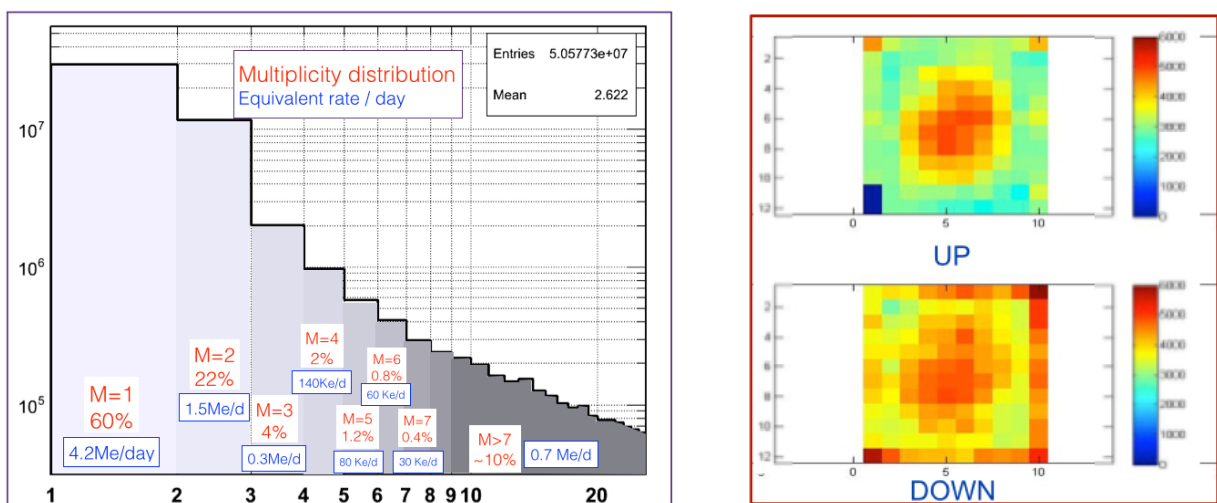

**Figure 6.** Left) Hit multiplicity distribution in the upper plane for a week of data collection with the corresponding equivalent rate per day. Right) Typical hit map in the upper and lower planes; the observed structures are explained in the text.

Figure 7 shows as a function of time, the evolution of the event multiplicity and the mean induced charge, together with the temperature profile of the atmosphere<sup>12</sup> and the position of the tropopause<sup>13</sup>. The upper and lower bounds given by the dotted lines correspond to the temperature interval  $\pm 2^\circ$  around the minimum. Data were collected between March 21st. and April 27th. 2014 when the air conditioner was not yet installed; as a consequence day by day oscillations are mainly due to the day-night changes on the room temperature.

Both quantities are slightly correlated to the altitude of the tropopause or, in other words, are anti-correlated with the ground pressure<sup>14</sup>. This circumstance may explain both behaviors: a higher pressure is usually associated to a higher density, and also to a higher absorption probability; as a consequence, an increase on the pressure should imply a decrease in the multiplicity of the events. Moreover, the induced charge it is expected to be correlated with the multiplicity because a high particle environment increase the chance that two or more particles arrive to the same cell increasing the collected charge.

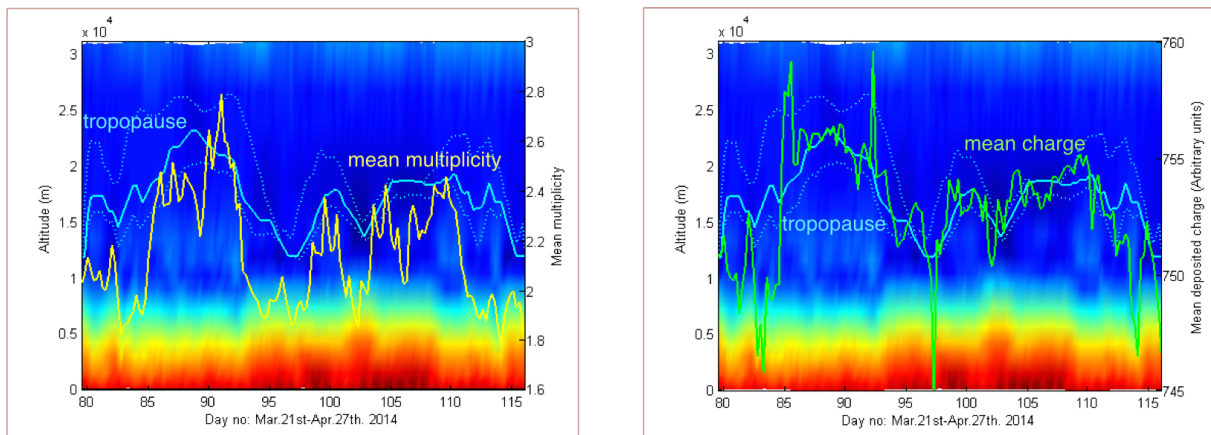

**Figure 7.** Time evolution of the tropopause altitude (light blue line; left axis) and several physical variables, between Mar. 21st. and Apr. 27th., 2014. The background color represents the temperature of the atmosphere: dark red for highest temperatures and dark blue for lowest temperatures. Left) Mean multiplicity (yellow line) evolution. Right) Mean charge (green line) evolution.

## 5. Summary

Unlike any other cosmic ray detector existing at the Earth surface, TRAGALDABAS combines both a high granularity and an outstanding time resolution with the tracking capability of charged particles. All this performances would allow to measure the multiplicity of a swarm of particles belonging to the same air shower while the good time resolution offers many advantages: on the one hand it reduces the tracking ambiguity in high multiplicity events and, on the other hand, it allows to select the first arriving particles of a cluster that are those that keep a better memory of the direction of the primary cosmic ray.

Unlike other detectors, the TRAGALDABAS doesn't make use of any intermediary absorber, being sensitive to both the muon and the electromagnetic component of the showers. According to primary results obtained in the analysis of the data taken during the commissioning of

<sup>12</sup> The temperature profiles have been extracted from the reanalysis NCEP/NCAR Data Base:  
<http://www.esrl.noaa.gov/psd/data/reanalysis/reanalysis.shtml>

<sup>13</sup> Lower temperature region between the troposphere and the stratosphere.

<sup>14</sup> A decrease/increase on the barometric pressure is usually associated to the ascent/descendent air movements that push the air upwards, lifting also up the position of the tropopause

the RPC detectors of HADES [7] we expect that electromagnetic and muon components of a shower can be statistically separated, analyzing the arrival time, the angular distribution and the induced charge together with all their correlations. This possibility may open new expectations related to a better understanding of the structure of the cosmic ray air showers in a broad range of energies and also of their relationship with different phenomena related with the Earth surrounding. A few of the research fields accesible to the detector are:

- Analysis of the microstructure of cosmic ray air showers.
- Analysis of the solar activity.
- Analysis of several space weather phenomena as magnetic plasma clouds or magnetic storms.
- Analysis of the Earth's magnetic field.
- Analysis of the temperature profile of the upper atmosphere.

Despite the limited size of the detector the outstanding performances it offers may allow to overcome, in many cases, the lack of statistics problem. In any case, it is expected that it may provide a significative step forward in the understanding of the cosmic ray evolution in the atmosphere and even open the door to the discovery of new effects.

### 5.1. Acknowledgments

We are very grateful to all our colleagues who made possible the development of the detector and its installation in the laboratory of the LabCAF at the Univ. of Santiago de Compostela, mainly Américo Pereira and Orlando Cunha, from LIP Coimbra and Dr. Michael Traxler, from GSI. We also acknowledge the C. Desarrollo de las Ciencias, of Madrid, for their partial financial support.

## References

- [1] P.K.F. Grieder. *Cosmic rays at Earth.*, Elsevier Science (2009).
- [2] J. Blümer et al. *Cosmic rays from the knee to the highest energies.*, *Prog. Part. & Nucl. Phys.* **63** (2009) 293338.
- [3] J. Linsley. *Mini and super mini arrays for the study of highest energy cosmic rays.*, *19th. Int. Cosmic Ray Conf. La Jolla* **3** (1985) 434-437.
- [4] T. Bezboruah et al. *A non conventional method of UHE cosmic ray detection.*, *Astropart. Phys.* **11** (1999) 395-402.
- [5] U.D. Goswami et al. *Reanalysis of GU miniarray data using CORSIKA*, *Astropart. Phys.* **22** (2005) 421-429.
- [6] A. Iyono et al. *Linsley's EAS time structure method for the primary cosmic ray spectrum at LAAS.*, *Astrophys. Space Sci. Trans.* **7** (2011) 335-344.
- [7] D. Belver et al. *Analysis of the space-time microstructure of cosmic ray air showers using the HADES RPC TOF wall*, *JINST* **7** (2012) P10007.
- [8] G. Agnetta et al. *Time structure of the extensive air shower front.*, *Astropart. Phys.* **6** (1997) 301-312.
- [9] W.D. Apel et al. *Time structure of the EAS electron and muon components measured by the KASCADE-Grande experiments.*, *Astropart. Phys.* **29** (2008) 317-330.
- [10] P. Sommers. *Experimental aspects fo cosmic rays*, Univ. of Utah, Salt Lake City, USA **UT84112-0830** (2008) <http://cds.cern.ch/record/1017823/files/p177.pdf>.
- [11] S. Sciutto *AIRES User Manual*, <http://www.fisica.unlp.edu.ar/auger/aires/>.
- [12] D. Belver et al. *TRASGO: A proposal for a timing RPCs based detector for analyzing cosmic ray air showers*, *Nucl. Instrum.& Meth.* **A661** (2012) S163-167.
- [13] A. Blanco et al. *TRAGALDABAS: a new RPC based detector for the regular study of cosmic rays*, *JINST* **9** (2014) C09027.
- [14] L. Lopes et al. *Resistive Plate Chambers for the Pierre Auger array upgrade*, *JINST* **9** (2014) C10023.
- [15] D. Belver et al. *Performance of the Low-Jitter High-Gain/Bandwidth Front-End Electronics of the HADES tRPC Wall*, *IEEE Trans. Nucl. Sci.* **57** (2010) 2848-2856.
- [16] I. Fröhlich et al. *A General Purpose Trigger and Readout Board for HADES and FAIR-Experiments*, *IEEE Trans. Nucl. Sci.* **55** (2008) 59-66.